

GC25RGD

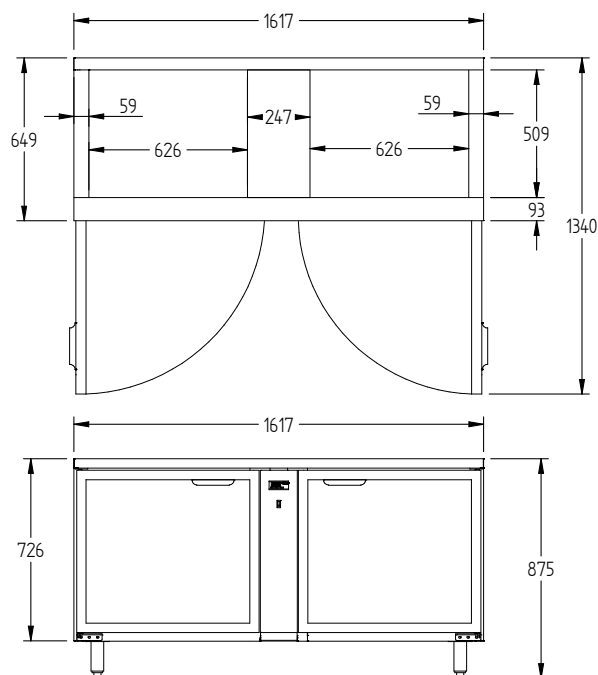

CATEGORY	GENERAL COUNTERS & BACK BARS
RANGE	Glass Chiller
UNIT	REFRIGERATOR
TYPE	REMOTE
DOORS	2

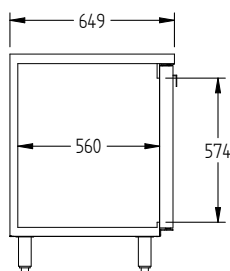

SPECIFICATIONS

CAPACITY - BASKETS/DOOR (NOT INCLUDED)(500 X 500 BASKET)	4 Baskets
TEMPERATURE	1°C / 4°C
SHELF LOAD	YES
DIMENSIONS - W X D X H (ON LEGS) MM	1617 W x 649 D x 875 H
WEIGHT UNPACKED (KG)	100

STANDARD INCLUSIONS ***

DOOR TYPE	Standard: GD (Glass Door)
FINISH (INTERIOR AND EXTERIOR EXCLUDING REAR AND UNDER)	SS (Stainless Steel)
SHELVES/DOOR - SHELF LOAD MODEL ONLY	2

ELECTRICAL

POWER SUPPLY	10 amp	
FRIDGE MODELS	RUNNING AMPS	0.5

GAS TYPE

REFRIGERANT	R404a
--------------------	-------

REFRIGERATION WATTAGES FOR REMOTE UNITS

REMOTE WATTAGES	750 @ -5° C SST
------------------------	-----------------

*** For **OPTIONS** refer to the current Williams Price Guide